

# Signet 8550 Flow Transmitters



Check out the 9900 Transmitter for your single channel needs

Member of the ProcessPro® Family of Instruments



Panel Mount



Pipe, Wall, Tank and Integral Mount

Signet 8550 Flow Transmitters are advanced instruments that convert the signal from frequency and digital (S<sup>3</sup>L) flow sensors into a 4 to 20 mA signal for long distance transmission. Configuration flexibility is maximized with dual input/output, two standard open collector outputs, two packaging options for integral/pipe mount or panel installation, and scalability for virtually any flow range or engineering unit. State-of-the-art electronic design ensures long-term reliability, signal stability, and simple user setup and operation.

## Features

- Two channel flow input/output
- 2 or 4 wire power
- Available with dual input & output
- 4 to 20 mA scaleable outputs
- Permanent & resettable totalizers
- NEMA 4X enclosure with self-healing window
- Output simulation for complete system testing



## Applications

- Flow Control and Monitoring
- Filtration or Softener Regeneration
- Effluent Totalization
- Pump Protection
- Feed Pump Pulsing
- Ratio Control
- Water Distribution
- Leak Detection

# Specifications

General		
Compatibility	Signet Flow Sensors with frequency outputs	
Accuracy	±0.5% of reading	
Display	Alphanumeric 2 x 16 LCD	
Update Rate	1 second	
Contrast	User selectable, 5 levels	
Materials		
Enclosure	PBT resin	
Keypad	Sealed 4-key silicon rubber	
Panel and Case Gasket	Neoprene	
Window	Polyurethane coated polycarbonate	
Electrical		
Power	12 to 24 VDC ±10%, regulated	
	100 mA max.	
Sensor Input Range (Dual)	0.5 to 1500 Hz	
Sensor Power	2-wire: 5 VDC ±1% @ 1.5 mA	
	3 or 4 wire: 5 VDC ±1% @ 20 mA	
	Optically isolated from current loop short circuit protected	
Current Output (Dual)	4 to 20 mA, isolated, passive, fully adjustable and reversible	
Max. Loop Impedance	50 Ω max. @ 12 V	
	325 Ω max. @ 18 V	
	600 Ω max. @ 24 V	
Update Rate	100 ms	
Accuracy	±0.03 mA	
Open-Collector Output		
	High, Low, Pulse, Off	
	Optically isolated, 50 mA max. sink, 30 VDC max. pull-up voltage.	
Hysteresis	User selectable for exiting alarm condition	
Maximum 400 pulses/min		
Environmental		
Operating Temperature	-10 °C to 70 °C	14 °F to 158 °F
Storage Temperature	-15 °C to 80 °C	5 °F to 176 °F
Relative Humidity	0 to 95%, non-condensing	
Enclosure	NEMA 4X/IP65 (front face only on panel mount); field mount is 100% NEMA 4X/IP65	
Shipping Weight		
	0.325 kg	0.7 lb
Standards and Approvals		
	CE, FCC, UL, CUL	
	RoHS compliant, China RoHS	
	Manufactured under ISO 9001 for Quality and ISO 14001 for Environmental Management and OHSAS 18001 for Occupational Health and Safety	

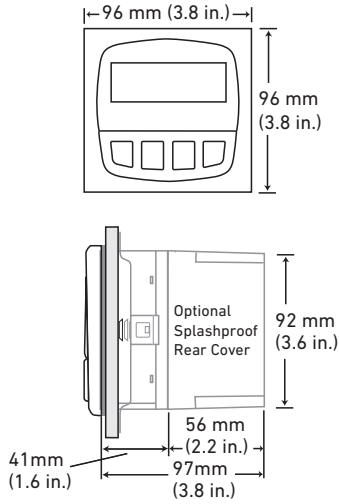

# Dimensions

## 3-8550-XP

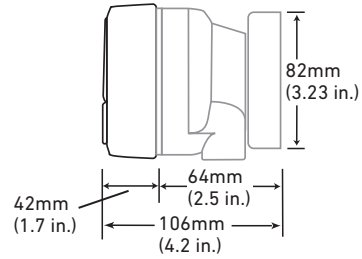

### Field version with universal mount

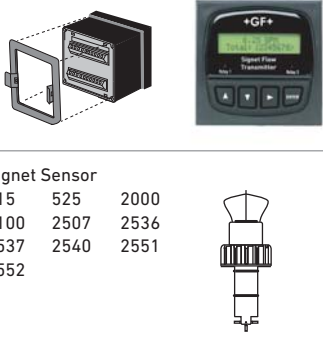
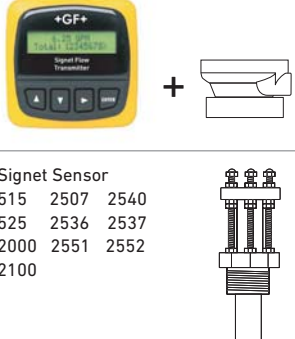

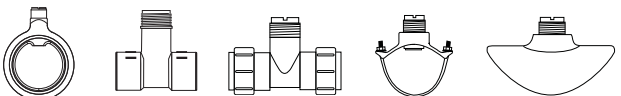
System Overview	<b>Panel Mount</b>	<b>Pipe, Tank, Wall Mount</b>	<b>Field (Integral) Mount</b>
	<b>Signet 8550 Flow Transmitter</b> (Includes mounting bracket and panel gasket)	<b>Signet 8550 Flow Transmitter</b> with 3-8050 Universal Mount Kit	<b>Signet 8550 Flow Transmitter</b> with 3-8051-X Integral Mount Kit
			
	Signet Sensor 515 525 2000 2100 2507 2536 2537 2540 2551 2552	Signet Sensor 515 2507 2540 525 2536 2537 2000 2551 2552 2100	Signet Integral Mount Sensor 3-8510-XX 3-8512-XX
<b>Signet Fittings</b>			All sold separately

### Ordering Notes

- 1) Use the field mount version to directly mount the instrument to the Model 515 or 2536 integral mount sensor. See sensor data sheet for more information.
- 2) Field mount and sensor can be ordered in a package. See Integral Mount for more information.
- 3) Panel cutout should be 92 mm X 92 mm (3.62 in X 3.62 in.).
- 4) An optional splashproof rear cover for the panel mount version can be ordered separately if needed.

Please refer to Wiring, Installation, and Accessories sections for more information.

## Ordering Information

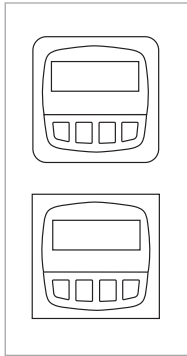

Mfr. Part No.	Code	Input	Output	Power
ProcessPro Flow Transmitter				
Field mount package				
3-8550-3	<b>159 000 051</b>	Two	Two 4 to 20 mA outputs and two open collectors for Hi, Lo, Pulse or Frequency	2 or 4 wire
Panel mount package				
3-8550-3P	<b>159 000 052</b>	Two	Two 4 to 20 mA outputs and two open collectors for Hi, Lo, Pulse or Frequency	2 or 4 wire

## Accessories and Replacement Parts

Mfr. Part No.	Code	Description
<b>Mounting Accessories</b>		
3-8050	<b>159 000 184</b>	Universal mounting kit
3-8051	<b>159 000 187</b>	Flow sensor integral mount, NPT
3-8051-1	<b>159 001 755</b>	Flow sensor integral mount kit, NPT, PP
3-8051-2	<b>159 001 756</b>	Flow sensor integral mount kit, NPT, PVDF
3-0000.596	<b>159 000 641</b>	Heavy duty wall mount bracket (panel mount only)
3-5000.399	<b>198 840 224</b>	Panel adapter, 5 x 5 in. to ¼ DIN
3-5000.598	<b>198 840 225</b>	Surface mount bracket (panel mount only)
3-8050.395	<b>159 000 186</b>	Splashproof rear cover (panel mount only)
3-9900.396	<b>159 001 701</b>	Angle adjustment adapter kit
<b>Liquid Tight Connectors and Other</b>		
3-9000.392	<b>159 000 368</b>	Liquid tight connector kit for rear cover (includes 3 connectors)
3-9000.392-1	<b>159 000 839</b>	Liquid tight connector kit, NPT (1 connector)
3-9000.392-2	<b>159 000 841</b>	Liquid tight connector kit, PG 13.5 (1 connector)